

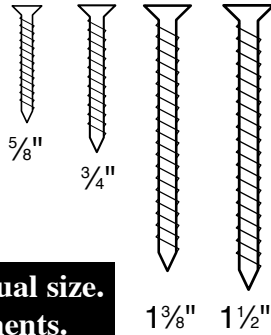

Bag contents:

Base Assembly

- 8 - Wooden dowels
- 12 - 1 1/2" Wood screws
- 6 - 1 3/8" Wood screws
- 16 - 3/4" Wood screws



**Screws shown at actual size.
Use for measurements.**

Check and Organize all Parts

It is recommended to dry fit the base and sides first. Then, for best results and maximum stability, secure all wood dowels with wood glue. Be careful to lay out and identify all parts before gluing. We also recommend laying out all hardware as you take it out of the bags. Separate into exact lengths. Several of the screws are similar in length.

(R#): Reorder Number

A-1 through A-3 Base and Sides: 6 Pieces as follows

- (1) BASE (R#1) - One edge will be finished
- (2) FRAME PIECES (R#2) - One long end will be finished 27 7/8" x 38 1/2"
- (2) SIDE PIECES (R#3) - Finished on one side, wooden drawer guides on other
- (1) BACK PIECE (R#4) - 39 1/2" x 16 3/8" Hardboard

A-1

1. Locate base, 1 frame and 4 wooden dowels. Place dowels in base, align frame with finished edge to finished edge of base, pre-drilled holes will face down. Gently tap into place using a soft rubber mallet. Secure with 3 - 1 3/8" screws.

A-1

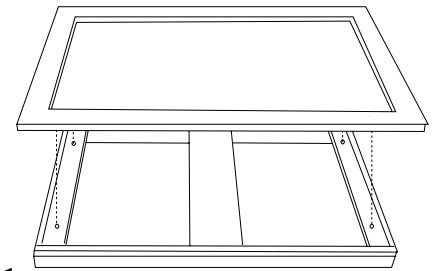

A-2

2. Find side pieces. You will be mounting these to the base. The finished edge will be to the front. (Match up with existing finished edge pieces) Notched edge MUST be to the back (unfinished edge). Place 4 plastic dowels in side piece. Align with base piece. Gently tap into place using a soft rubber mallet. Secure with 3 - 1 1/2" wood screws. Repeat on other side.

A-2

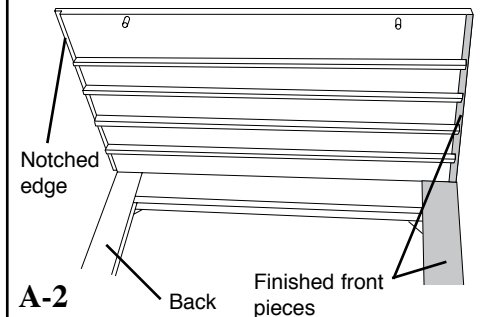

A-3

3. Find last frame piece. Align with dowels placed in side pieces. You may need to loosen a side piece for the initial fit. Once in, tighten side again. Be sure to have finished side to front and pre-drilled holes facing up. Once in place, secure with 6 - 1 1/2" screws.

A-3

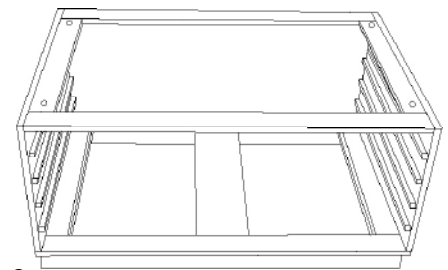

Back and top: Locate HARDBOARD (R#5) & FINISHED TOP (R#6)

A-4

4. Locate hardboard, 39 1/2" x 16 3/8" with pre-drilled holes. This is the back of your flat file. Align on back of frame, smooth side out, fitting into slots on both sides and bottom. Secure with 16 - 3/4" screws.

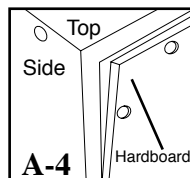

A-5

5. Locate top finished piece. Align with 4 wooden dowels and press top piece into place. Be sure finished beveled edge is to front. Secure on inside with 3 - 1 3/8" screws. **Failure to use the correct size screw could result in damage to your flat file top.**

A-5

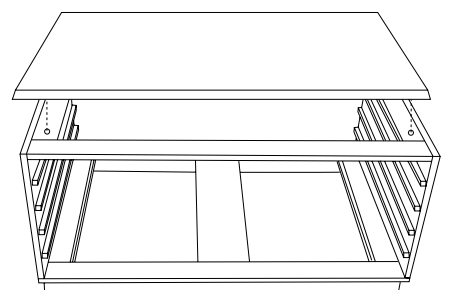

Bag contents:

Drawer Assembly

- 8 - Plastic dowels
- 2 - Wooden dowels
- 7 - $\frac{5}{8}$ " Wood screws
- 5 - $\frac{3}{4}$ " Wood screws
- 3 - $1\frac{3}{8}$ " Wood screws
- 4 - $1\frac{1}{2}$ " Wood screws

Bag contents:

Handles

- 4 - Gold bolts
- 2 - Gold handles

Use chart on first page to measure screws.

Check and Organize all Parts

It is recommended to dry fit the 1st drawer as a pattern. Then, for best results and maximum stability, secure all wood dowels with wood glue. Be careful to lay out and identify all parts before gluing.

We also recommend laying out all hardware as you take it out of the bags. Separate into exact lengths. Several of the screws are similar in length.
FAILURE TO USE THE PROPER SCREW LENGTH COULD RESULT IN DAMAGE TO DRAWER FRONT!!!

A-1 Drawer frame: 4 Pieces as follows

- (1) PLAIN PIECE (R#7) - back of drawer frame $37'' \times 1\frac{1}{4}'' \times \frac{5}{8}''$
- (2) SIDE PIECES - Right side piece (R#8) and left side piece (R#9)
 $26\frac{9}{16}'' \times 2\frac{1}{16}'' \times \frac{5}{8}''$
- (1) FRONT PIECE (R#10) - pre-drilled holes, front of frame $37'' \times 2\frac{9}{16}'' \times \frac{5}{8}''$

A-2 Drawer top/back and bottom: 2 Pieces as follows

- (1) BACK SUPPORT on drawer (R#11) - Hardboard board $3\frac{1}{2}'' \times 38\frac{3}{8}''$
- (1) BOTTOM of drawer (R#12) - Hardboard board $26\frac{1}{8}'' \times 37\frac{3}{8}''$

A-3 Drawer front: 1 Piece as follows

- (1) FINISHED FACE PIECE (R#13) - $3\frac{1}{2}'' \times 39''$

A-1

1. Locate plain piece. This will be the back of your drawer.
2. Find 2 side pieces. There will be a right and a left. When pieces are laid down parallel, pre-cut slots will face in toward each other. There will be a grooved section on the top of each piece, these have to be on the same end and will be closest to the back piece of your drawer.
3. Find front piece. Pre-drilled holes face out, pre-cut slot will face in.
4. Insert plastic dowels into the ends of the front and back pieces. Align all 4 pieces on the floor. Using the $4\frac{1}{2}''$ wood screws, secure on all four corners.

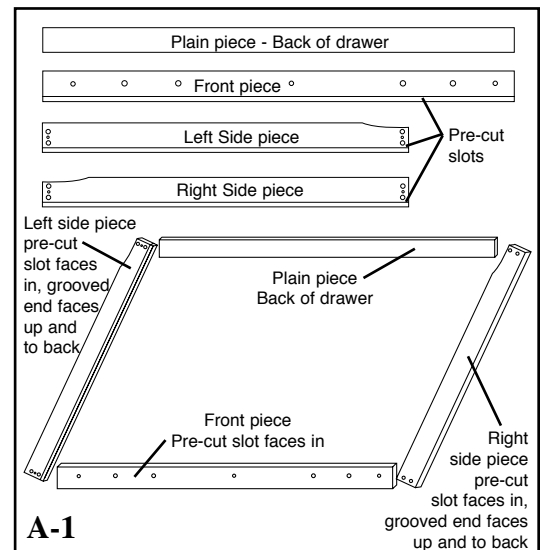

A-1

A-2

5. Locate $3\frac{1}{2}'' \times 38\frac{3}{8}''$ piece of hardboard board and 7 - $\frac{5}{8}''$ wood screws. Find grooved area on side pieces on back of drawer frame. Lay hardboard piece on top of back of frame, pre-drilled holes in hardboard will face out. **BEGIN SECURING ON THE CORNERS FIRST!** Snug hardboard piece up to one edge squaring it up with the frame. There will be no pre-drilled holes in frame. If using an electric screw driver, slow your drill speed down and apply a slight pressure. Align screw with pre-drilled hole in hardboard, secure to frame. Do both corners first, then the middle.
6. Find large hardboard piece with pre-drilled holes. Thread large piece of hardboard in pre-cut slot, smooth finish up and pre-drilled holes to the back of drawer (they will slide in last). Make sure hardboard board is snug to bottom. **Note: If corners of hardboard get damaged, trim flat with a razor.* Turn drawer over on a flat surface. Locate 5 - $\frac{3}{4}''$ wood screws to attach large hardboard piece to drawer frame. Align screws with pre-drilled holes in hardboard board. There will be no pre-drilled holes on frame. Secure with wood screws.

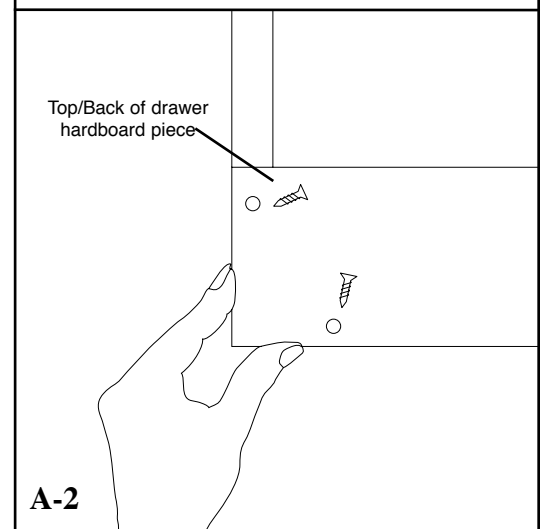

A-2

A-3

7. Locate finished face piece. To attach face piece to front of drawer take 2 wooden dowels and insert on the back of the finished face piece. Stand drawer on end, back of drawer to floor. Align dowels with pre-drilled holes and tap on to frame. On carpet or soft surface turn drawer so finished face piece is down. Locate 3 - $1\frac{3}{8}''$ wood screws. secure in 3 pre-drilled holes on front inside piece of drawer frame.
8. To attach handles to drawer, thread 2 - 1" gold bolts from inside to out. Using a flathead screwdriver to secure bolts to handle on front. Repeat other side.
9. Once you are sure you have successfully assembled one drawer and it fits into the flat file frame, you may proceed with other drawers gluing as you assemble.

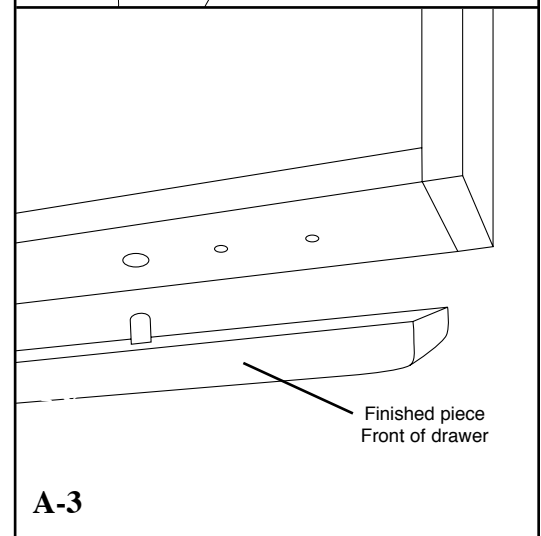

A-3